

## COMPOSANTS EN POUCES COMPONENTS IN IMPERIAL SIZES

Description - Description		Type	Page
	TETE DE GUIDAGE EN POUCES INCH HEAD BUSH	SUR DEMANDE / ON REQUEST	
		CGIN	152
	PISTON EN POUCES INCH PISTON	SUR DEMANDE / ON REQUEST	
		CTIN	152
	FOND EN POUCES INCH END PLUG	SUR DEMANDE / ON REQUEST	
		CFIN	153
	FOND INTERNE EN POUCES INCH INTERNAL END PLUG	SUR DEMANDE / ON REQUEST	
		CFIP	153
	BOSSAGE TARAUDE SAE SAE THREADED PORT	SUR DEMANDE / ON REQUEST	
		CBSJ	154
	BOSSAGE TARAUDE NPT NPT THREADED PORT	SUR DEMANDE / ON REQUEST	
		CBSNPT	154
	ECROU DE BLOCAGE PISTON SAE SAE LOCKNUT	SUR DEMANDE / ON REQUEST	
		CDAIN CDBIN	154
	POCHETTES DE JOINTS SEAL KITS	SUR DEMANDE / ON REQUEST	
		GKG	155

CGIN

TETE DE GUIDAGE EN POUCES  
INCH HEAD BUSH

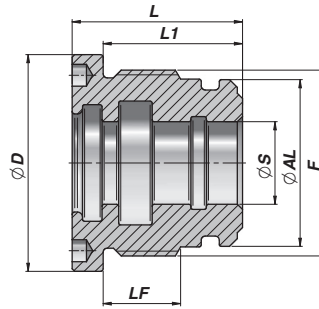
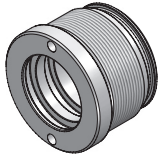

Code Code	ØAL	ØS	ØD	F	LF	L	L1	kg	Pochette de joints Seal kits
CGIN134112034	1"1/2	3/4"	1.875	1"3/4 - 12 UN	0.875	1.812	1.500	0,36	GKGGP1120034
CGIN212200118	2"	1"1/8	2.520	2"1/4 - 16 UN	0.827	1.875	1.500	0,55	GKGGP2000118
CGIN300212118	2"1/2	1"1/8	2.992	2"3/4 - 16 UN	0.906	2.250	1.875	1,10	GKGGP2120118
CGIN300212114	2"1/2	1"1/4	"	"	"	"	"	1,00	GKGGP2120114
CGIN300212112	2"1/2	1"1/2	"	"	"	"	"	0,85	GKGGP2120112
CGIN312300112	3"	1"1/2	3.504	3"1/4 - 16 UN	1.181	2.300	1.925	1,50	GKGGP3000112
CGIN312300134	3"	1"3/4	"	"	"	"	"	1,33	GKGGP3000134
CGIN400312134	3"1/2	1"3/4	4.016	3"3/4 - 12 UN	1.260	2.375	2.000	2,35	GKGGP3120134
CGIN400312200	3"1/2	2"	"	"	"	"	"	2,10	GKGGP3120200
CGIN412400200	4"	2"	4.488	4"1/4 - 12 UN	1.772	3.250	2.750	4,00	GKGGP4000200
CGIN412400212	4"	2"1/2	"	"	"	"	"	3,20	GKGGP4000212
CGIN558500212	5"	2"1/2	5.669	5"1/4 - 12 UN	1.969	3.375	2.875	6,80	GKGGP5000212
CGIN558500234	5"	2"3/4	"	"	"	"	"	6,30	GKGGP5000234
CGIN558500300	5"	3"	"	"	"	"	"	5,80	GKGGP5000300
CGIN634600300	6"	3"	6.693	6"1/4 - 12 UN	2.165	3.688	3.125	9,40	GKGGP6000300
CGIN634600312	6"	3"1/2	"	"	"	"	"	8,30	GKGGP6000312

MATERIEL : FONTE EN-GJL 250 (G25-UNI 5007/EN 1561)

MATERIAL : HYDRAULIC CAST IRON EN-GJL 250 (G25-UNI 5007/EN 1561)

JOINTS : VOIR PAGE 155

SEALS : SEE PAGE 155

CTIN

PISTON EN POUCES  
INCH PISTON

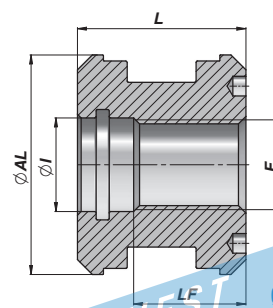
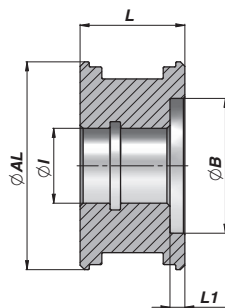
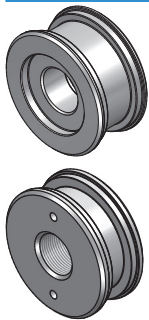

Code Code	ØAL	ØI	L	ØB	L1	F	LF	kg	Pochette de joints Seal kits
CTIN112016100	1"1/2	0.630	1.000	1.102	0.125	-	-	0,11	GKGTP112M160
CTIN200020112	2"	0.787	1.500	1.299	0.188	-	-	0,30	GKGTP200M200
CTIN212020112	2"1/2	0.787	1.500	1.625	0.188	-	-	0,58	GKGTP212M200
CTIN212023112	2"1/2	0.906	1.500	1.625	0.188	-	-	0,53	GKGTP212M230
CTIN300030134	3"	1.181	1.750	1.890	0.250	-	-	0,82	GKGTP300M300
CTIN312033134	3"1/2	1.299	1.750	2.283	0.313	-	-	1,20	GKGTP312M330
CTIN400033134	4"	1.299	1.750	2.500	0.313	-	-	1,88	GKGTP400M330
CTIN500040200	5"	1.575	2.188	3.000	0.500	-	-	3,35	GKGTP500M400
CTIN600052214	6"	2.047	2.375	-	-	2-12 UN	1.784	5,90	GKGTP600M520

MATERIEL : ACIER 9SMn28 - UNI C40

MATERIAL : STEEL 9SMn28 - UNI C40

JOINTS : VOIR PAGE 155

SEALS : SEE PAGE 155

FOND EN POUÇES  
INCH END PLUG

CFIN

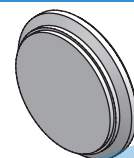
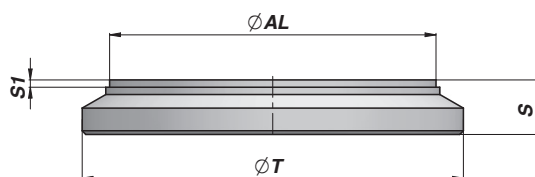

Code Code	ØAL	ØT	S1	S	kg
CFIN112200012	1"1/2	1.875	0.500	0.094	0,15
CFIN200212012	2"	2.500	0.500	0.125	0,26
CFIN212300012	2"1/2	2.963	0.500	0.125	0,38
CFIN300312012	3"	3.543	0.590	0.125	0,66
CFIN312400034	3"1/2	3.937	0.690	0.125	1,00
CFIN400412034	4"	4.500	0.750	0.125	1,45
CFIN500558078	5"	5.709	0.880	0.125	2,75
CFIN600634100	6"	6.750	1.000	0.125	4,30

MATERIEL : ACIER S355JO ( Fe510C ) - S355JR ( A105 )  
 MATERIAL : STEEL S355JO ( Fe510C ) - S355JR ( A105 )

FOND INTERNE EN POUÇES  
INCH INTERNAL END PLUG

CFIP

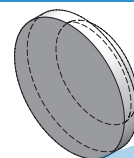
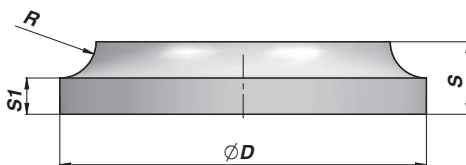

Code Code	ØAL	ØT	S	S1	R	kg
CFIP012200	2"	2.047	0.472	0.196	0.276	0,17
CFIP015212	2"1/2	2.559	0.591	0.315	0.276	0,27
CFIP015300	3"	3.071	0.591	0.276	0.315	0,47
CFIP017312	3"1/2	3.543	0.669	0.354	0.315	0,77
CFIP020400	4"	4.055	0.787	0.393	0.394	1,10
CFIP023500	5"	5.039	0.906	0.434	0.472	1,90
CFIP025600	6"	6.063	0.984	0.512	0.472	3,30

Ø AL = TUBE: ALESAGE - TUBE: BORE

MATERIEL : ACIER S355JO ( Fe510C ) - S355JR ( A105 )  
 MATERIAL : STEEL S355JO ( Fe510C ) - S355JR ( A105 )

**CBSJ**

**BOSSAGE TARAUDE SAE  
SAE THREADED PORT**

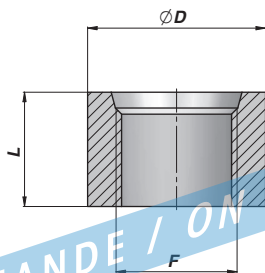
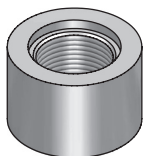

Code Code		L	ØD	kg X 100
CBSJ475006	9/16" - 18 UNF SAE 06	0.708	0.866	3,50
CBSJ475008	3/4" - 16 UNF SAE 08	0.708	1.102	5,20
CBSJ475012	1"1/16 - 12 UN SAE 12	1.023	1.496	13,00
CBSJ475016	1"1/2 - 12 UN SAE 16	1.259	1.771	20,50

MATERIEL : ACIER  
MATERIAL : STEEL

**CBSNPT**

**BOSSAGE TARAUDE NPT  
NPT THREADED PORT**

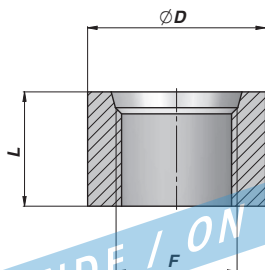
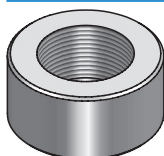

Code Code	F	L	ØD	kg X 100
CBSNPT0000014	1/4" NPT	0.500	1.024	3,00
CBSNPT0000038	3/8" NPT	0.500	1.024	3,00
CBSNPT0000012	1/2" NPT	0.687	1.260	6,00
CBSNPT0000034	3/4" NPT	0.687	1.496	8,00

MATERIEL : ACIER  
MATERIAL : STEEL

**CDAIN/CDBIN**

**ECROU DE BLOCAGE PISTON SAE  
SAE LOCKNUT**

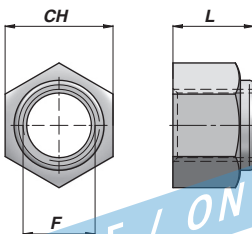
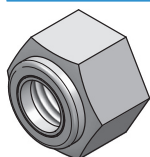

Code Code	F	L	CH	kg x 100	Code Code	F	L	CH	kg x 100
CDAIN00012020	1/2" - 20 UNF	0.591	0.748	2,00	CDBIN00114012	1"1/4 - 12 UNF	1.102	1.811	24,00
CDAIN00058018	5/8" - 18 UNF	0.748	0.945	5,00					
CDAIN00034016	3/4" - 16 UNF	0.866	1.063	7,00					
CDAIN00078014	7/8" - 14 UNF	0.984	1.260	10,00					
CDAIN00118012	1"1/8 - 12 UNF	1.181	1.614	21,00					
CDAIN00114012	1"1/4 - 12 UNF	1.378	1.811	34,00					
CDAIN00112012	1"1/2 - 12 UNF	1.614	2.165	48,00					

MATERIEL : ACIER UNI 7473 - 7474 - NYLON  
MATERIAL : STEEL UNI 7473 - 7474 - NYLON

**KIT JOINTS POUR TETE DE GUIDAGE "CGIN"**  
**SEAL KITS FOR "CGIN" HEAD BUSH**
**GKGGP**

Code Code	Alésage/Tige Bore/Rod	O-Ring Dowty	GHK	TTI-L TTI - TSE	O-Ring Dowty
GKGGP1120034	1"1/2 - 3/4"	-	3/4"	TTI 19.50- 25.40	219
GKGGP2000118	2" - 1"1/8	137	1"1/8	TTI 28.57- 36.50	828
GKGGP2120118	2"1/2 - 1"1/8	145	1"1/8	TTI 28.57- 36.50	835
GKGGP2120114	2"1/2 - 1"1/4	145	1"1/4	TTI 31.75- 41.27	835
GKGGP2120112	2"1/2 - 1"1/2	145	1"1/2	TTI 38.10- 47.62	835
GKGGP3000112	3" - 1"1/2	151	1"1/2	TTI 38.10- 47.62	843
GKGGP3000134	3" - 1"3/4	151	1"3/4	TTI 44.45- 53.97	843
GKGGP3120134	3"1/2 - 1"3/4	238	1"3/4	TTI 44.45- 53.97	236
GKGGP3120200	3"1/2 - 2"	238	2"	TTI 50.80- 60.32	236
GKGGP4000200	4" - 2"	242	2"	TTI 50.80- 60.32	342
GKGGP4000212	4" - 2"1/2	242	2"1/2	TTI 63.50- 76.20	342
GKGGP5000212	5" - 2"1/2	250	2"1/2	TTI 63.50- 76.20	860
GKGGP5000234	5" - 2"3/4	250	2"3/4	TTI 69.80- 82.50	860
GKGGP5000300	5" - 3"	250	3"	TTI 76.20- 88.90	860
GKGGP6000300	6" - 3"	258	3"	TTI 76.20- 88.90	868
GKGGP6000312	6" - 3"1/2	258	3"1/2	TTI 88.90-101.60	868

**KIT JOINTS POUR PISTON "CTIN"**  
**SEAL KITS FOR "CTIN" PISTON**
**GKGTP**

Code Code	Alésage/Perç. Piston Bore/Hole	TPM/P	O-Ring Dowty
GKGTP112M160	1"1/2 - 0.630	1500-1125	114
GKGTP200M200	2" - 0.787	2000-1375	117
GKGTP212M200	2"1/2 - 0.787	2500-1875	117
GKGTP212M230	2"1/2 - 0.906	2500-1875	213
GKGTP300M300	3" - 1.181	3000-2250	217
GKGTP312M330	3"1/2 - 1.299	3500-2750	219
GKGTP400M330	4" - 1.299	4000-3250	219
GKGTP500M400	5" - 1.575	5000-4000	824
GKGTP600M520	6" - 2.047	6000-5000	832